

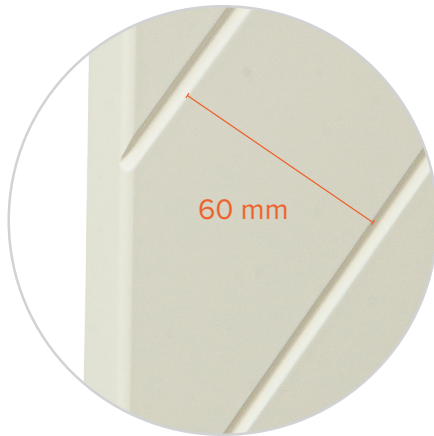

LAMELKI



JODEŁKA



BIEŻNIK

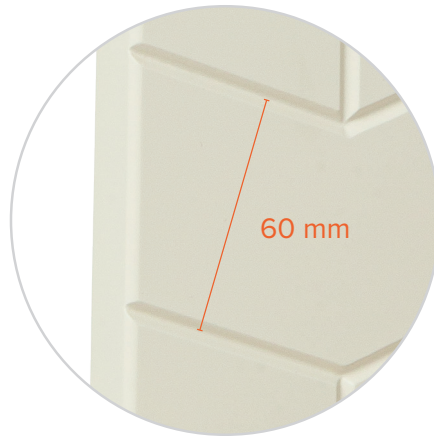

FRONTY RAMOWE

IBS/R2

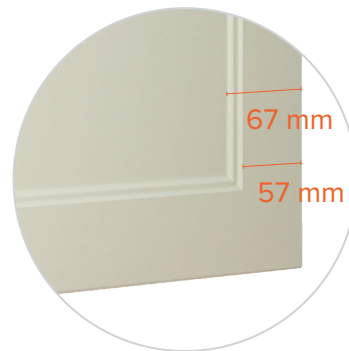

BARSAK/R2

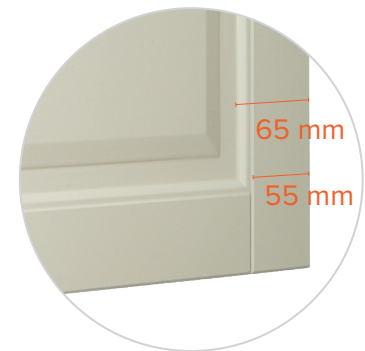

P/5/R2

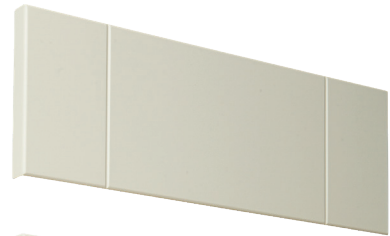

PR/6/R2

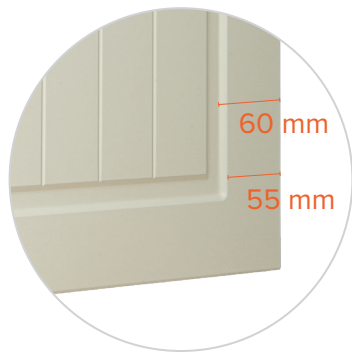

PR/9/R2

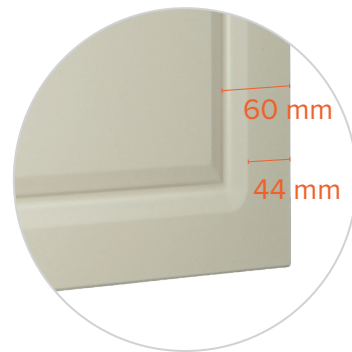

PR/10/R2

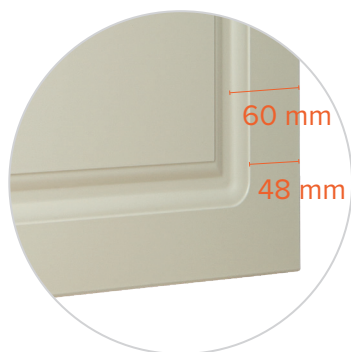

PR/11/R2



PR/20/R2

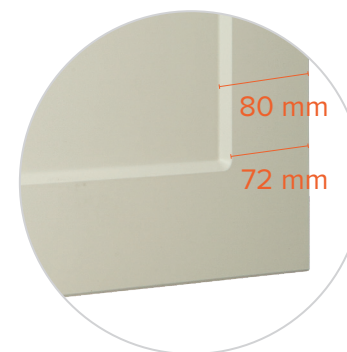

PR/21/R2

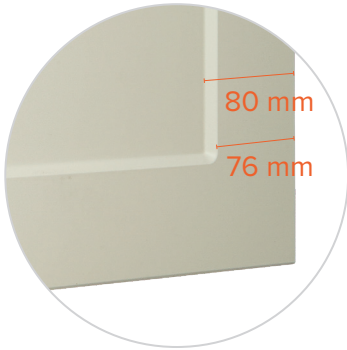

PR/33/R2

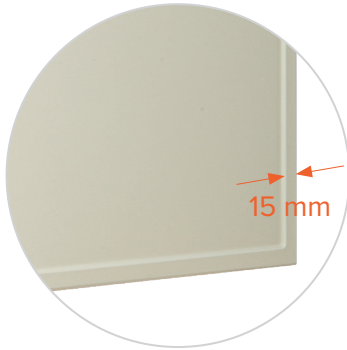

PR/50/R2

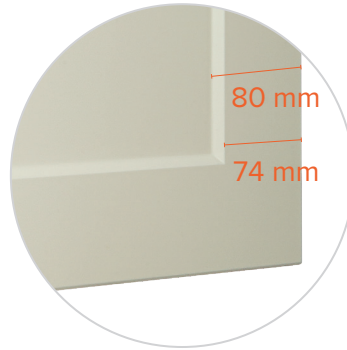

PR/51/R2



GLOBAL/R2



AVINA/R2

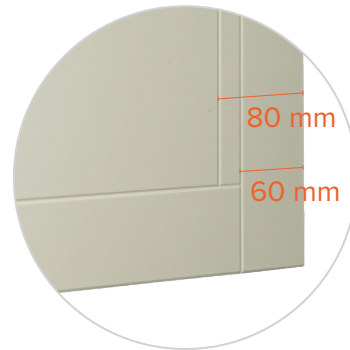

LOTUS/R2

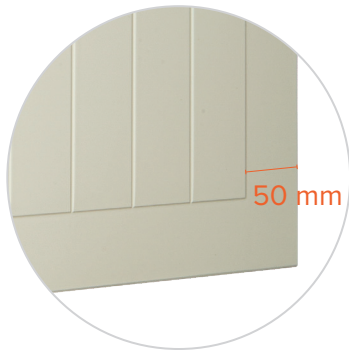

MEFO/R2



S1/RAJO/R2

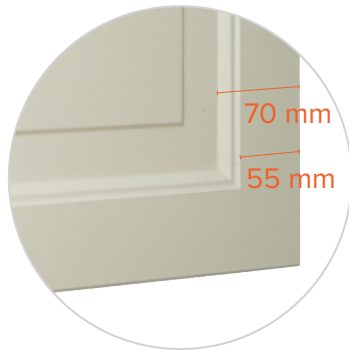

P/3/MSM



GRZEŚ/R2

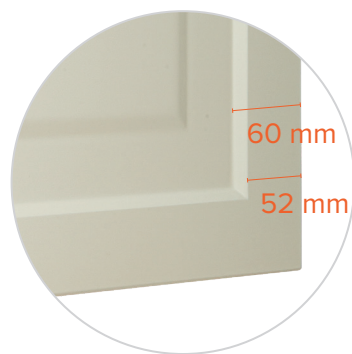

MEGAN/R2

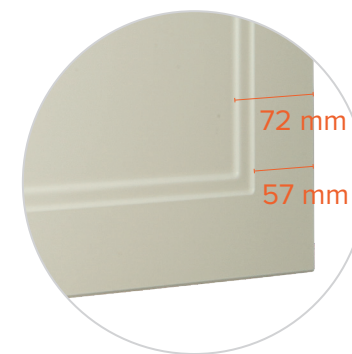

MARYSIA/R2

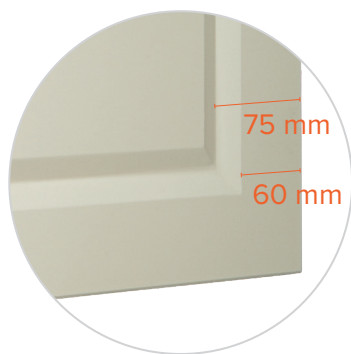

RAMONA/R2

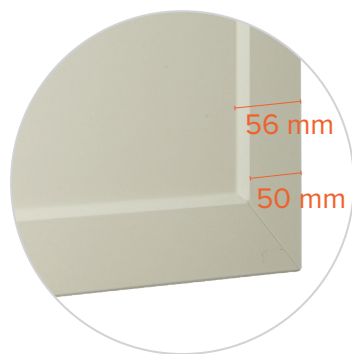
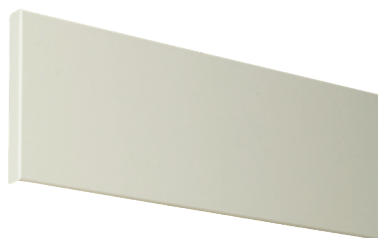

KEG/R2
STANDARDOWA GRUBOŚĆ: 22 mm

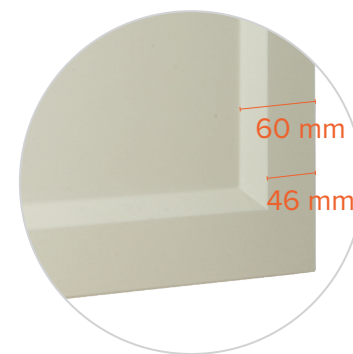



WITRYNY

WITRYNA W1



WITRYNA W2

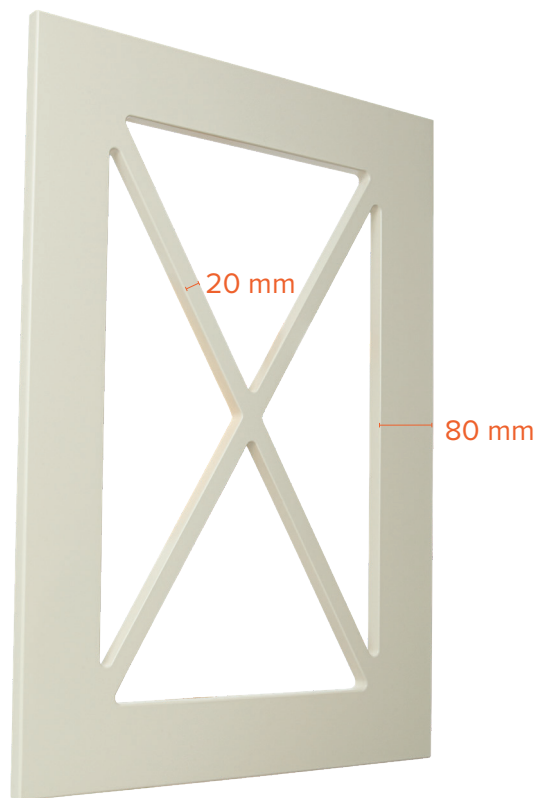

WITRYNA W3

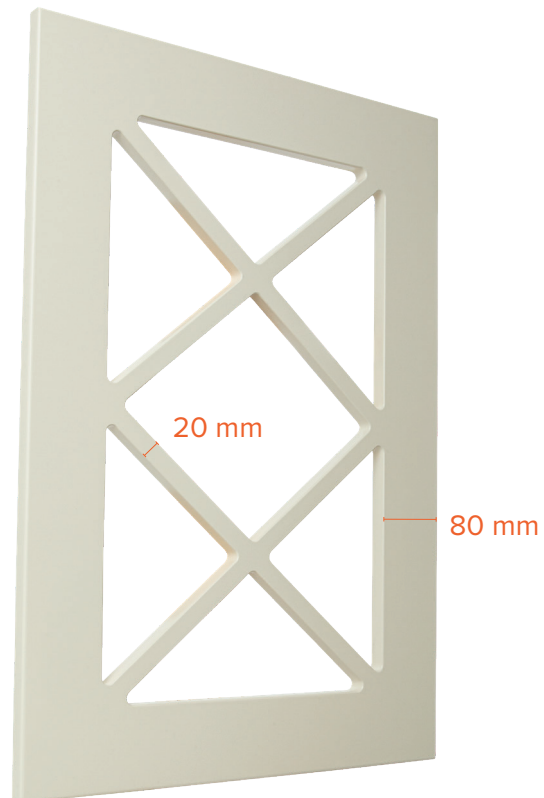

WITRYNA W4

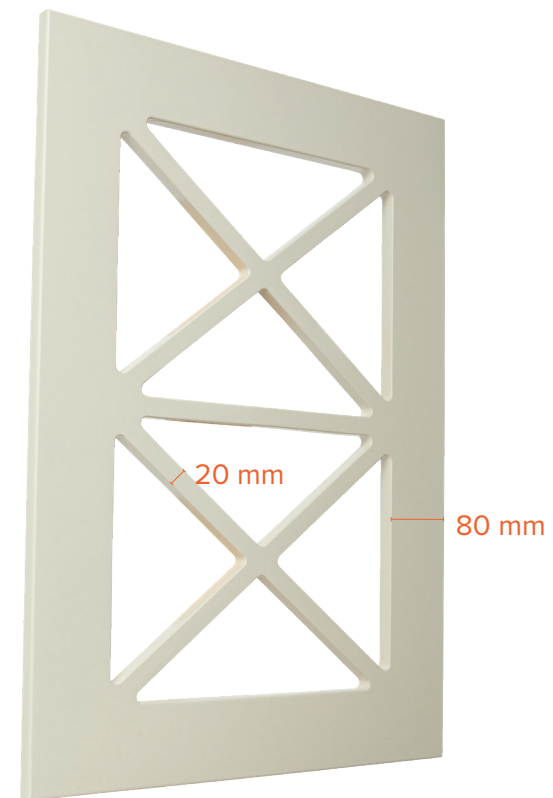

WITRYNA W5

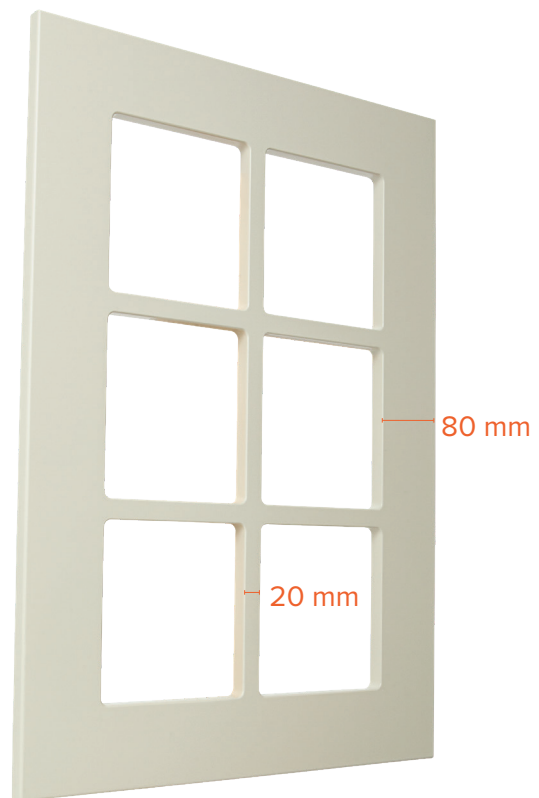

WITRYNA W6

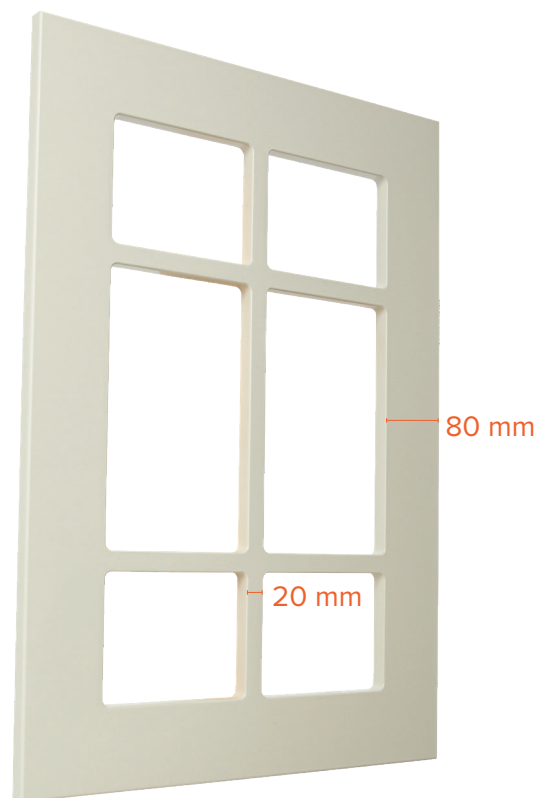

WITRYNA W7





UCHWYTY
FREZOWANE

UCHWYT „A”

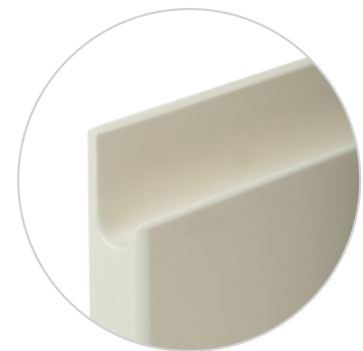

UCHWYT „B”

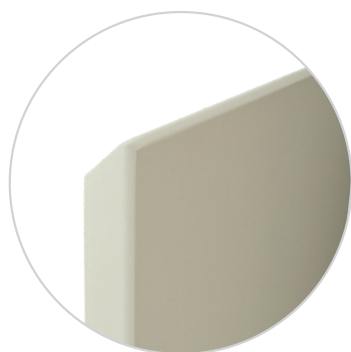

UCHWYT „C”



UCHWYT „E”

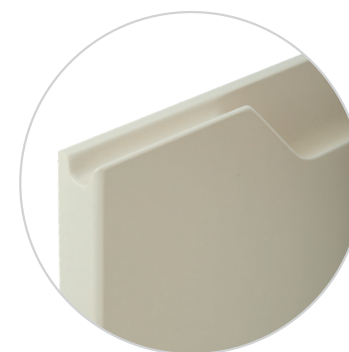

UCHWYT „F”



UCHWYT „UKW5”

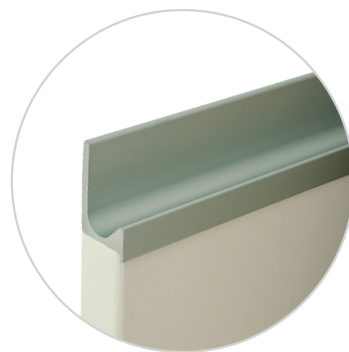

UCHWYT „UKW7”

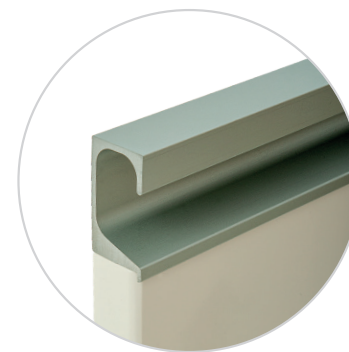



PILASTRY
LISTWY
WIEŃCZĄCE

PILASTER P1



PILASTER P2



PILASTER P3



LISTWA LW13

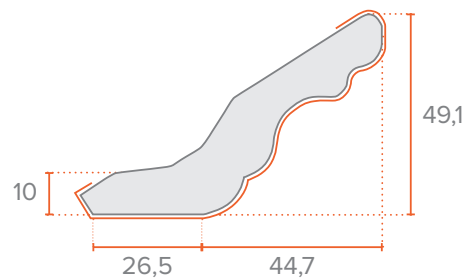
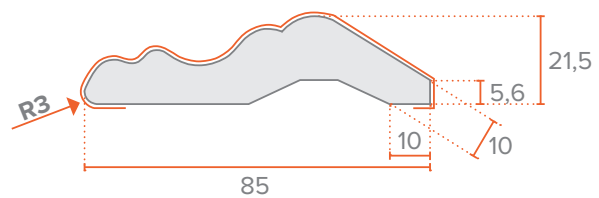

LISTWA LW16

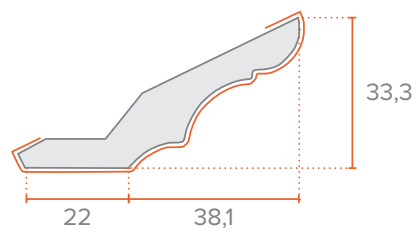
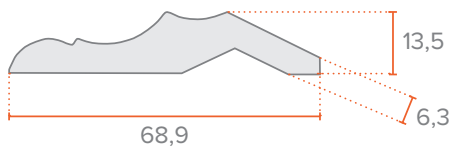

LISTWA LW25

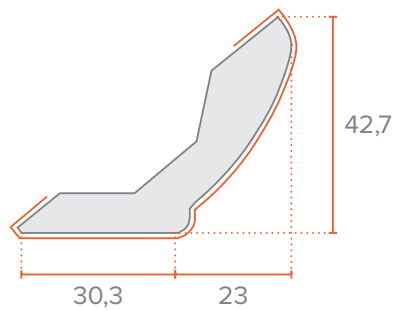
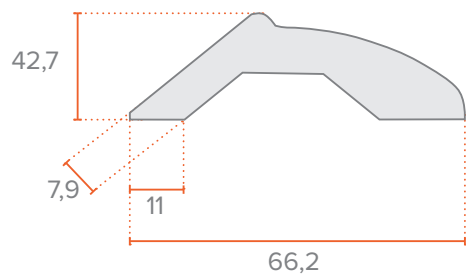

LISTWA LW27

